

Linear

LINI-R R207

Fixture Guide

KKDÖ



Indoor | Recessed | Dynamic output up to 546lm/m (166lm/ft)



Key applications

- ✓ Ceiling
- ✓ Interior
- ✓ Direct lighting
- ✓ Special effect
- ✓ Downlighting

Key features

- ✓ Custom lengths
- ✓ IP40 dry area
- ✓ Constant Voltage (CV)
- ✓ IP44 moisture resistant
- ✓ Diffusion: homogenous
- ✓ LEDmix dynamic white
- ✓ Extensive CCT range

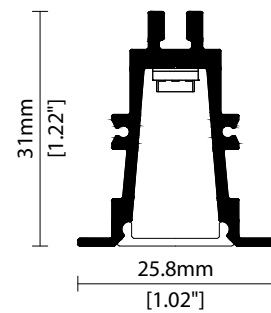

Warm-dim

Output Luminance %

min DIM1 Input Level max

— CH1 (Warmer)
— CH2 (Cooler)

LEDmix R207

CCT Selection 1 CCT Selection 2

LEDmix R209

CCT Selection 1 CCT Selection 2

LEDmix **warm dim** (Dynamic white) is a pre-programmed dimming curve setting enabling two different colour temperatures (CCTs) to blend harmoniously to achieve a warming lighting effect when dimmed.

KKDC LEDmix strips allow two separate CCT selections to be specified within the same PCB strip.

Use the table opposite to help determine which 2 CCT selections you require according to your preferred cool to warm dimming range.

**Note: The blended CCT is approx. 'cool-end' result at 100% brightness based on using the KKDC LED CCT specification.*

CCT Selection 1	CCT Selection 2	
	Blended CCT*	PCB CCT
1900K~	2000K 2100K 2200K 2300K 2500K 2600K 2700K 3000K 3500K	2100K PCB 2300K PCB 2500K PCB 2700K PCB 3000K PCB 3200K PCB 3500K PCB 4000K PCB 5000K PCB
2100K~	2200K 2300K 2400K 2600K 2700K 2800K 3000K 3600K	2300K PCB 2500K PCB 2700K PCB 3000K PCB 3200K PCB 3500K PCB 4000K PCB 5000K PCB
2300K~	2400K 2500K 2700K 2800K 2900K 3100K 3700K	2500K PCB 2700K PCB 3000K PCB 3200K PCB 3500K PCB 4000K PCB 5000K PCB
2500K~	2600K 2800K 2800K 3000K 3200K 3800K	2700K PCB 3000K PCB 3200K PCB 3500K PCB 4000K PCB 5000K PCB
2700K~	2900K 3000K 3100K 3400K 3900K	3000K PCB 3200K PCB 3500K PCB 4000K PCB 5000K PCB
3000K~	3100K 3300K 3500K 4000K	3200K PCB 3500K PCB 4000K PCB 5000K PCB
3200K~	3300K 3600K 4100K	3500K PCB 4000K PCB 5000K PCB
3500K~	3700K 4300K	4000K PCB 5000K PCB
4000K~	5100K	5000K PCB

Tuneable white

Channel Mix Ratio %

min DIM1 Input Level max

— CH1 (Warmer)
— CH2 (Cooler)

LEDmix R207

CCT Selection 1 CCT Selection 2

LEDmix R209

CCT Selection 1 CCT Selection 2

LEDmix **tunable white** enables two different LED colour temperatures (CCTs) to be specified within the same LEDmix strip.

Each CCT selection can then be independently controlled (via your dimming control system) to adjust the warm & cool light output (CCT selections) and thus tailor a blended light colour of your choosing.

CCT Selection 1	CCT Selection 2
1900K~	2100K 2300K 2500K 2700K 3000K 3200K 3500K 4000K 5000K
2100K~	2300K 2500K 2700K 3000K 3200K 3500K 4000K 5000K
2300K~	2500K 2700K 3000K 3200K 3500K 4000K 5000K
2500K~	2700K 3000K 3200K 3500K 4000K 5000K
2700K~	3000K 3200K 3500K 4000K 5000K
3000K~	3200K 3500K 4000K 5000K
3200K~	3500K 4000K 5000K
3500K~	4000K 5000K
4000K~	5000K

Linear

LINE-R R207

Specification sheet



Dimensions	H31/W25.8/L100-2017mm (H1.22/W1.02/L3.93-79.41in) (excluding spring clips)
PCB Cut-point	83.3mm increment/2000mm max (3.28in increment/78.74in max)
LED Pitch	13.9mm-144LED/m (0.55in - 44LED/ft)
Chip	s-line k-line
Cover/Optics	Diffused (110°)
CCT	s-line: 1900K/2100K/2300K/2500K/2700K/3000K/3500K/4000K/5000K k-line: 1900K/2100K/2300K/2500K/2700K/3000K/3500K/4000K/5000K
LED binning	s-line: 2-step MacAdam ellipse k-line: 3-step MacAdam ellipse
CRI	≥94
Lifetime	50,000 hours @ 25°C (50,000 hours @ 77°F)
Operating temp	T _a = -25 to 50°C (T _c max = 63°C) T _a = -13 to 122°F (T _c max = 145.4°F)
IP Rating	IP40/IP44
Finish	Silver anodised
Mounting	Recessed mounting via spring clip
Power feed	Hardwire tails or male/female connectors
Control	0-10V/1-10V/DMX/DALI



LED Grading Key

Exclusive Grade

s s-line*	*KKDC tuned CCT range
2-step CCT range	

Base Grade

k k-line	3-step commercial range
	Energy Star CCTs

Power consumption	Supply voltage	Supply current
16W/m (4.88W/ft)	24V DC	0.67A/m (0.20A/ft)

Performance Data (2100K+5000K)

	R1	R2	R3	R4	R5	R6	R7	R8	R9	R10	R11	R12	R13	R14
k-line	97	96	97	97	97	92	94	94	91	94	96	78	96	99

Diffused Cover

											CRI	R9	Rf	Rg
s-line	546lm/m (166lm/ft)										96	92	-	-
	34.1lm/W													
k-line	515lm/m (157lm/ft)										95	91	-	-
	32.2lm/W													

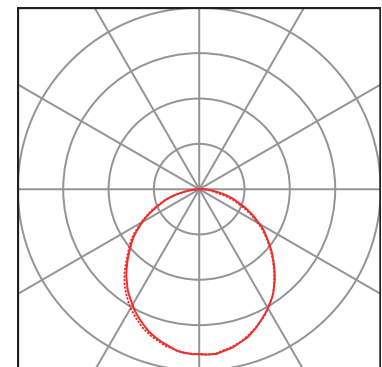
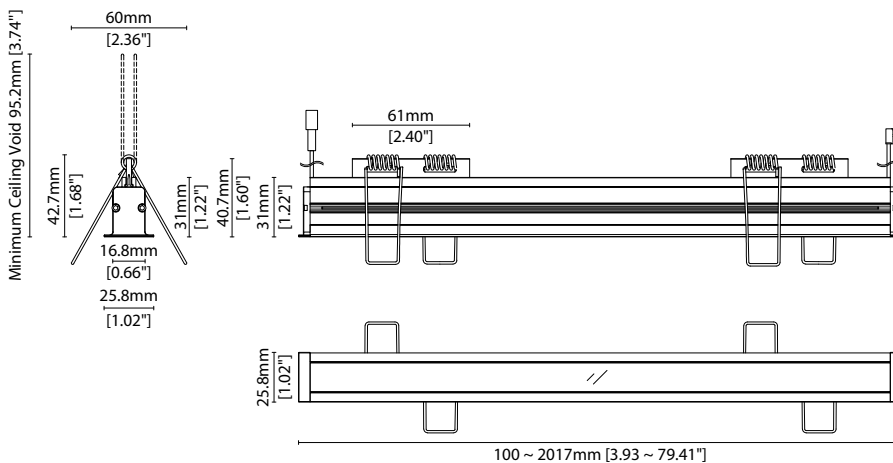

Data derived from independent UKAS / IESNA LM-79-08 accredited testing of production samples.

FIXTURE

Model	Finish	Cover ¹	Grade ²	LED	Colour (CCT)	Length Availability ³	IP	Cable Length	Power Feed ⁴	Input												
LINEI-R	LR Silver Anodised	SA Diffused	C s ⁵ s k ⁵ k	R207	R207	1900K	19	m	100.3-2017mm 83.3mm increments	IP40	40	50mm/1.97"	0050	Single no sheath tail	S00X	DC 24V	g					
						2100K	21						IP44	44	300mm/11.81"	0300						
						2300K	23	i								1000mm/39.37"	1000	Double no sheath tail	D00X			
						2500K	25															
						2700K	27											Single no sheath IP20 connector	S20X			
						3000K	30															
						3500K	35															
						4000K	40															
						5000K	50												Double no sheath IP20 connector	D20X		

¹ Refer to **Cover/Lens Options** on **Options** page

² Refer to **LED Grading Key** on **Specification sheet** page

³ Refer to **Length Availability List** or enter total run length instead of length code

⁴ Refer to **Power Feed Options** on **Options** pages

⁵ LEDmix requires two colour temperature choices

Code Example:

LR	-	SA	-	C	-	s	-	R207	-	2150	-	m	-	517	-	40	-	0300	-	D00X	-	g
LINEI-R		Silver Anodised		Diffused				R207		2100K+5000K		517mm		IP40		300mm/11.81"				Double no sheath tail		DC 24V

ACCESSORIES

Connection Accessories

KKCN-18	4 PIN LEDmix male & female 50mm/1.97" pair
KKCN-19	4 PIN LEDmix male & female 300mm/11.81" pair
KKCN-24	4 PIN LEDmix 300mm/11.81" extension lead

PSU/Driver

0-10V/1-10V/DALI/DMX

* Refer to **Driver/PSU Options** page for details or provide requirement and KKDC to offer the suitable option

* Refer to **Power feed** on **Accessories** pages

LED ENGINE VARIANTS (LED STRIP TYPE)

Colour	LED	Lumen/m	Lumen/ft	W/m	W/ft	Spec Doc	Length	Increment
Single CCT	R007	230	70	7	2.13	LINEI-R R007	100-2017mm (3.93-79.41in)	41.7mm (1.64in)
	R014	475	145	14	4.27	LINEI-R R014	100-2017mm (3.93-79.41in)	41.7mm (1.64in)
	R020	678	207	20	6.10	LINEI-R R020	100-2017mm (3.93-79.41in)	41.7mm (1.64in)
Warm Dim/Dynamic White	R207	546	166	16	6.10	LINEI-R R207	100-2017mm (3.93-79.41in)	83.3mm (3.28in)
RGB	501	Red: 54 Green: 116 Blue: 19 RGB: 167	Red: 16 Green: 35 Blue: 6 RGB: 51	15.6	4.75	LINEI-R RGB	100-2017mm (3.93-79.41in)	83.3mm (3.28in)

* Performance data: s-line, 2100K + 5000K, diffused cover

LINE-R R207

Length Availability List

Length Code		Fixture Length ¹		LED Strip ²		End Cap Dimension		Wattage (W)	Output (lm) 3000K (Test Data)
Metric	Imperial(US)	Metric	Imperial(US)	Metric	Imperial(US)	Metric	Imperial(US)		
m0100	i0004	100mm	3.95in	83mm	3.28in	12mm	0.47in	1.33	43
m0184	i0007	184mm	7.23in	167mm	6.56in	12mm	0.47in	2.67	85
m0267	i0011	267mm	10.51in	250mm	9.84in	12mm	0.47in	4.00	128
m0350	i0014	350mm	13.79in	333mm	13.12in	12mm	0.47in	5.33	171
m0434	i0017	434mm	17.07in	417mm	16.40in	12mm	0.47in	6.67	213
m0517	i0020	517mm	20.35in	500mm	19.69in	12mm	0.47in	8.00	256
m0600	i0024	600mm	23.64in	583mm	22.97in	12mm	0.47in	9.33	299
m0684	i0027	684mm	26.92in	667mm	26.25in	12mm	0.47in	10.67	341
m0767	i0030	767mm	30.20in	750mm	29.53in	12mm	0.47in	12.00	384
m0850	i0033	850mm	33.48in	833mm	32.81in	12mm	0.47in	13.33	427
m0934	i0037	934mm	36.76in	917mm	36.09in	12mm	0.47in	14.67	469
m1017	i0040	1017mm	40.04in	1000mm	39.37in	12mm	0.47in	16.00	512
m1100	i0043	1100mm	43.32in	1083mm	42.65in	12mm	0.47in	17.33	555
m1184	i0047	1184mm	46.60in	1167mm	45.93in	12mm	0.47in	18.67	597
m1267	i0050	1267mm	49.88in	1250mm	49.21in	12mm	0.47in	20.00	640
m1350	i0053	1350mm	53.16in	1333mm	52.49in	12mm	0.47in	21.33	683
m1434	i0056	1434mm	56.44in	1417mm	55.77in	12mm	0.47in	22.67	725
m1517	i0060	1517mm	59.72in	1500mm	59.06in	12mm	0.47in	24.00	768
m1600	i0063	1600mm	63.01in	1583mm	62.34in	12mm	0.47in	25.33	811
m1684	i0066	1684mm	66.29in	1667mm	65.62in	12mm	0.47in	26.67	853
m1767	i0070	1767mm	69.57in	1750mm	68.90in	12mm	0.47in	28.00	896
m1850	i0073	1850mm	72.85in	1833mm	72.18in	12mm	0.47in	29.33	939
m1934	i0076	1934mm	76.13in	1917mm	75.46in	12mm	0.47in	30.67	981
m2017	i0079	2017mm	79.41in	2000mm	78.74in	12mm	0.47in	32.00	1024

¹ Actual total overall length of light fixture (LED strip + end caps + void/wire hole)

² Actual length of PCB strip

³ Actual length of 2x end caps

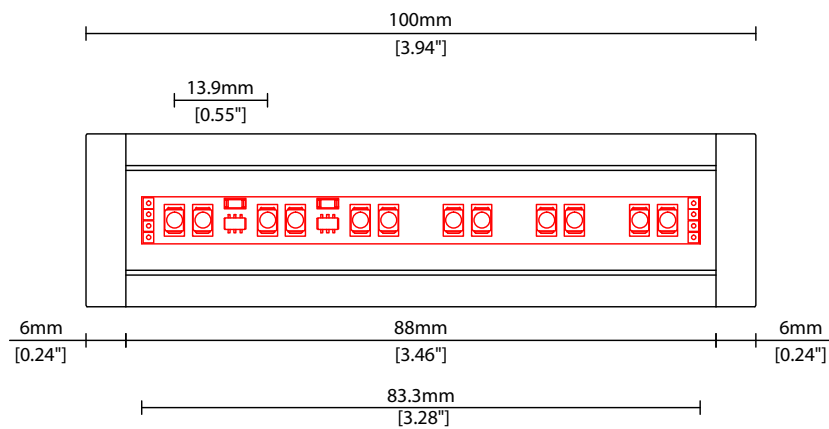



LINI-R R207

Options



COVER/LENS OPTIONS

* Options are an integral part of the fixture ordering codes. Please refer to **Code Table** pages.

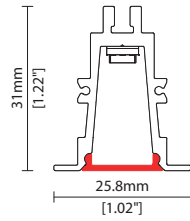

C Diffused cover
W25.8/H31mm (W1.02/H1.22")

POWER FEED OPTIONS

* Options are an integral part of the fixture ordering codes. Please refer to **Code Table** pages.

0050 S20X 50mm (1.97") Single no sheath IP20 connector

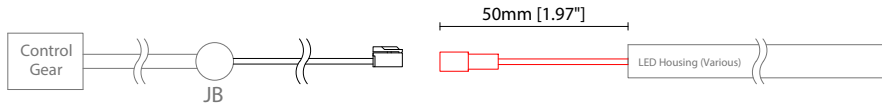

0050 D20X 50mm (1.97") Double no sheath IP20 connector

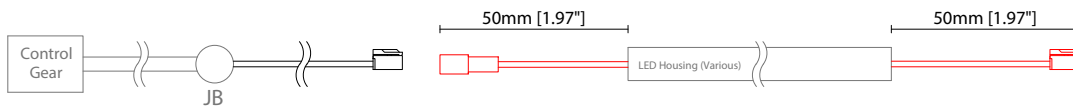

0300 S00X 300mm (11.81") Single no sheath tail

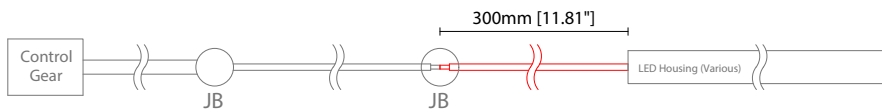

0300 D00X 300mm (11.81") Double no sheath tail

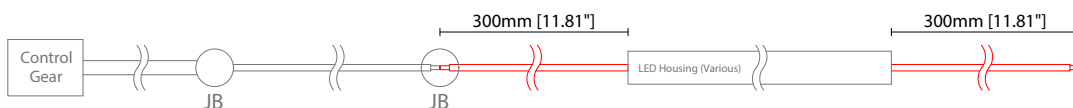

0300 S20X 300mm (11.81") Single no sheath IP20 connector

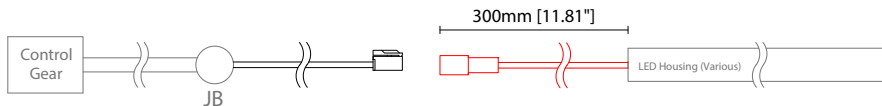

0300 D20X 300mm (11.81") Double no sheath IP20 connector

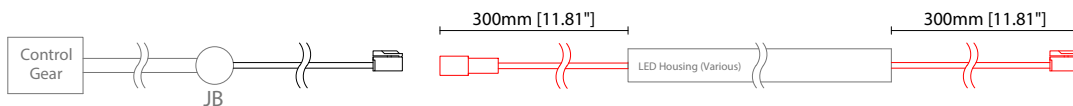

1000 S00X 1000mm (39.37") Single no sheath tail

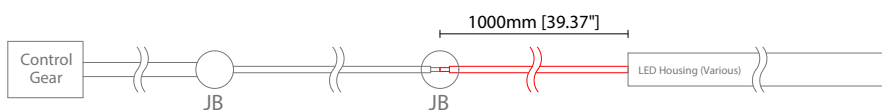

1000 D00X 1000mm (39.37") Double no sheath tail

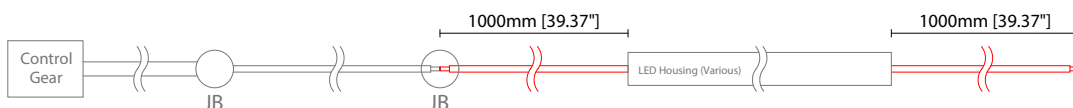

1000 S20X 1000mm (39.37") Single no sheath IP20 connector

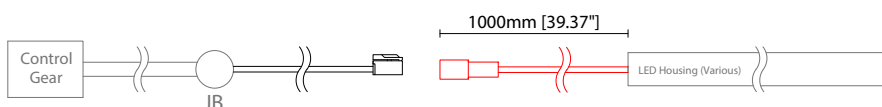

Key

Control Gear Power supply, sub-controllers & control systems

JB Junction box / cable connection

POWER FEED OPTIONS (CONTINUED)

1000 D20X 1000mm (39.37") Double no sheath IP20 connector

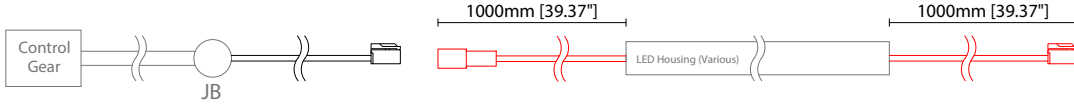

4 Pin LEDmix Female Connector

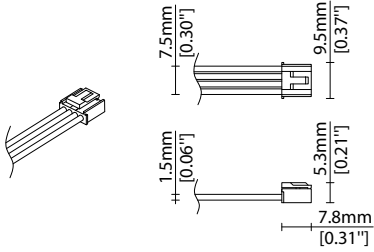

4 Pin LEDmix Male Connector

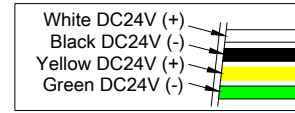
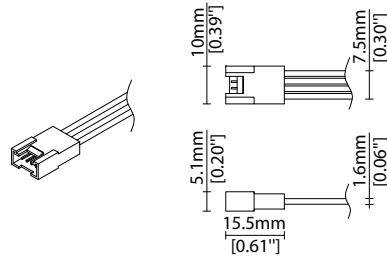

Key

Control Gear Power supply, sub-controllers & control systems
 JB Junction box / cable connection

POWER FEED

Note: Accessories are to be ordered separately with corresponding code shown below.

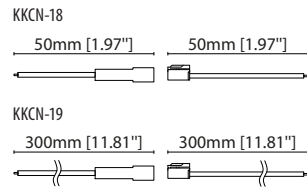
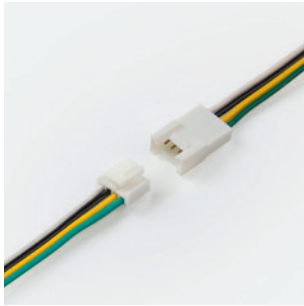

KKCN-18 50mm (1.97in) pair
KKCN-19 300mm (11.81in) pair
4 PIN LEDmix male + female
connector set

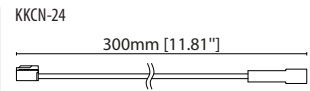

KKCN-24
4 PIN LEDmix 300mm (11.81in)
extension lead

KKDC CONTROL



IP20
Plastic housing
L170/W59/H29mm
(L6.69/W2.32/H1.14in)

KKDM-06 1-10V
visDIM dimmable sub-controller
(4 x 8A max @ 12-36V)



IP20
Plastic housing
L170/W53.4/H28mm
(L6.69/W2.10/H1.10in)

KKSC-05 DMX
visDIM dimmable sub-controller
(4 x 5A max @ 12-36V)



IP20
Plastic housing
L170/W59/H29mm
(L6.69/W2.32/H1.14in)

KKDL-02 DALI
visDIM dimmable sub-controller
(4 x 8A max @ 12-36V)



IP20
Plastic housing
L166/W53.4/H23mm
(L6.54/W2.10/H0.91in)

KKDL-03 DALI
visDIM dimmable sub-controller
(4 x 5A max @ 12-36V)



IP20
Plastic housing
L170/W53.4/H28mm
(L6.69/W2.10/H1.10in)

KKDL-04 DALI-2
visDIM dimmable sub-controller
(4 x 5A max @ 12-36V)

AVAILABLE PSU OPTIONS

Control Mode	PSU (Order Code)	Input Voltage AC	Output Voltage DC	Rated Output Current	Rated Power	Dim %	IP Rating
Switched	CEN-60-24	90-295V	24V	2.5A	60W	-	IP67
	HLG-60H-24	90-305V	24V	2.5A	60W	-	IP67
	HLG-100H-24	90-305V	24V	4.0A	100W	-	IP67
	HLG-150H-24	90-305V	24V	6.3A	150W	-	IP67
	HLG-240H-24	90-305V	24V	10A	240W	-	IP67
0-10V (1-10V)	PWM-40-24	90-305V	24V	1.67A	40W	100-0.15 (100-10)	IP67
	PWM-60-24	90-305V	24V	2.5A	60W	100-0.15 (100-10)	IP67
	PWM-90-24	90-305V	24V	3.67A	90W	100-0.15 (100-10)	IP67
	PWM-120-24	90-305V	24V	5.0A	120W	100-0.15 (100-10)	IP67
DALI	LIN100A1	120-277V	24V	1A per channel	100W	100-0.1	IP66/IP40
DMX RGB	LIN100A1	120-277V	24V	1.33A per channel	100W	100-0.1	IP66/IP40
DMX RGBW	LIN100A1	120-277A	24V	1A per channel	100W	100-0.1	IP66/IP40

Flicker Free Options - Combination of PSU+ sub-controller

Control Mode	PSU (Order Code)	Sub-controller (Order Code)	Input Voltage AC	Output Voltage DC	Rated Output Current	Rated Power	Dim %	IP Rating PSU/ Sub-controller
0-10V or 1-10V	CEN-60-24	KKDM-06	90-295V	24V	2.5A	60W	100-0.9	IP67/IP20
	HLG-60H-24	KKDM-06	90-295V	24V	2.5A	60W	100-0.9	IP67/IP20
	HLG-100H-24	KKDM-06	90-295V	24V	4.0A	100W	100-0.9	IP67/IP20
	HLG-150H-24	KKDM-06	90-295V	24V	6.3A	150W	100-0.9	IP67/IP20
	HLG-240H-24	KKDM-06	90-295V	24V	10.0A	240W	100-0.9	IP67/IP20
DALI	CEN-60-24	KKDL-02/03/04/visDIM PRO 30	90-295V	24V	2.5A	60W	100-0.1	IP67/IP20
	HLG-60H-24	KKDL-02/03/04/visDIM PRO 30	90-305V	24V	2.5A	60W	100-0.1	IP67/IP20
	HLG-100H-24	KKDL-02/03/04/visDIM PRO 30	90-305V	24V	4.0A	100W	100-0.1	IP67/IP20
	HLG-150H-24	KKDL-02/03/04/visDIM PRO 30	90-305V	24V	6.3A	150W	100-0.1	IP67/IP20
	HLG-240H-24	KKDL-02/03/04/visDIM PRO 30	90-305V	24V	10.0A	240W	100-0.1	IP67/IP20
DMX RGB	CEN-60-24	KKSC-05	90-295V	24V	2.5A	60W	100-0.9	IP67/IP20
	HLG-60H-24	KKSC-05	90-305V	24V	2.5A	60W	100-0.9	IP67/IP20
	HLG-100H-24	KKSC-05	90-305V	24V	4A	100W	100-0.9	IP67/IP20
	HLG-150H-24	KKSC-05	90-305V	24V	6.3A	150W	100-0.9	IP67/IP20
	HLG-240H-24	KKSC-05	90-305V	24V	10.0A	240W	100-0.9	IP67/IP20

¹ The items shown above cover the most frequently used specification but does not exhaust the possible options

² PSU and/or driver can be chosen from the table, or KKDC may recommend the best option upon receipt of the controls requirement and installation environment

³ Electrical shop drawing will include detailed information of PSU and relevant control drivers

⁴ Cut sheets are available on the controls section of www.kkdc.lighting or upon request